

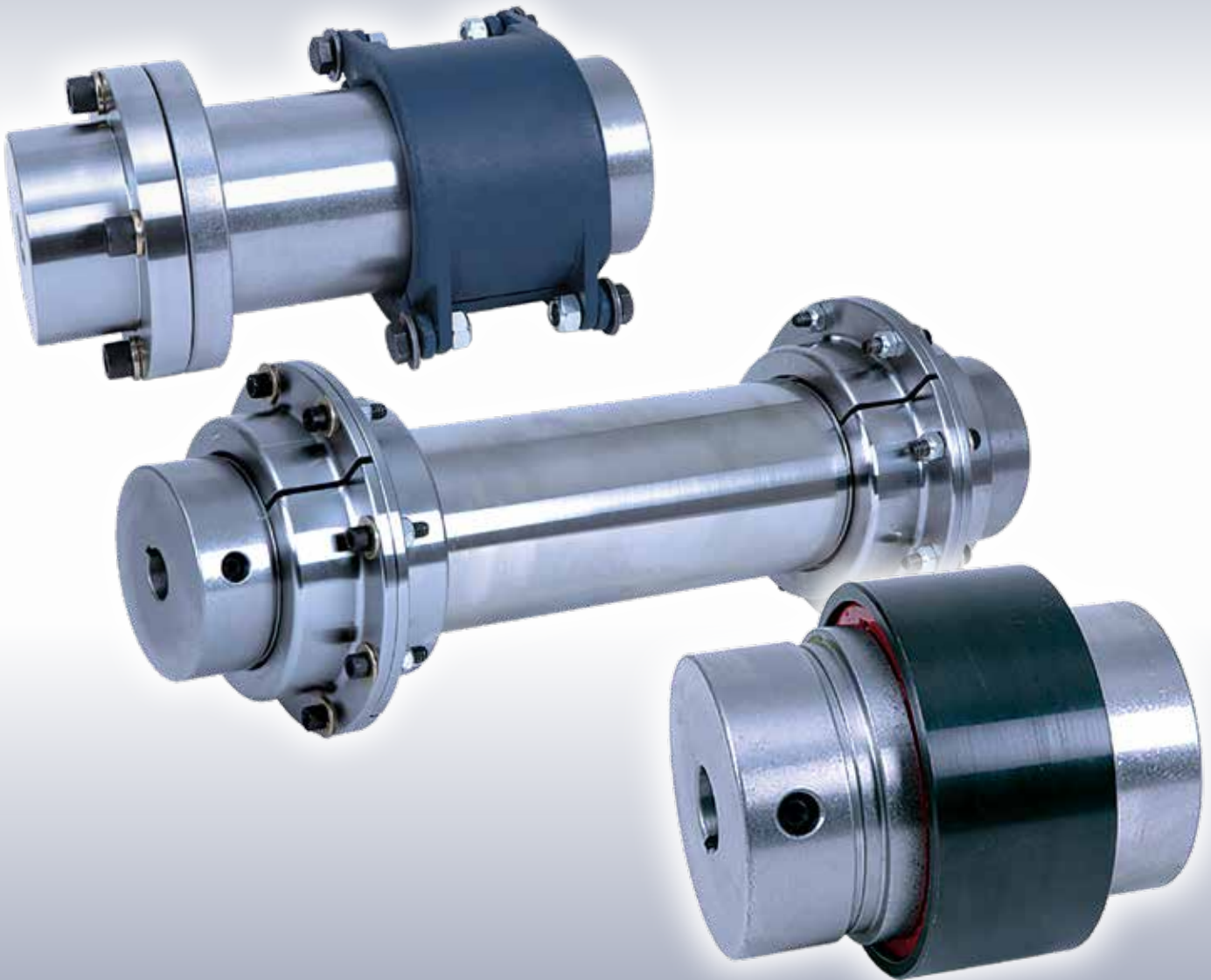

QUICK FLEX[®] Couplings

Interchange Guide

for Gear, Grid, Elastomeric, Disc & Chain



Better Performance. Less Maintenance.

Standard Coupling Nomenclature

A complete standard coupling unit consists of:

- Two hubs
- One insert
- One cover

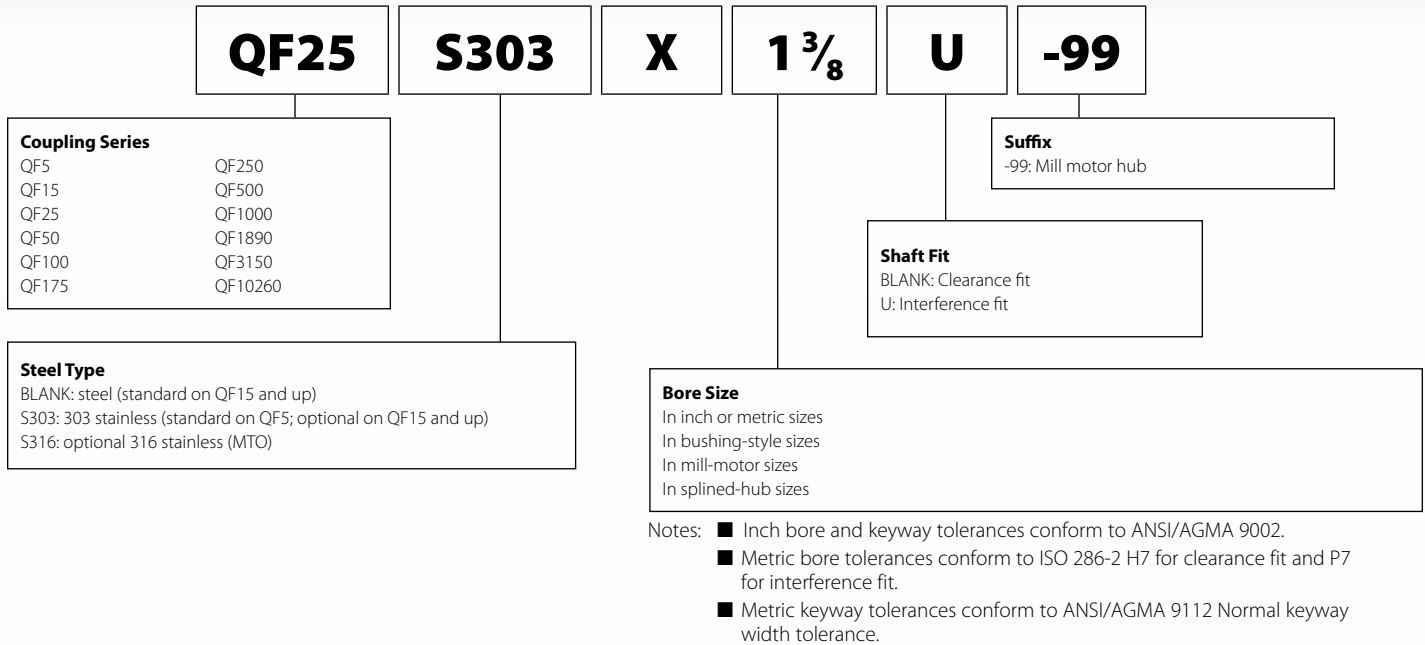

Fig. 1. Hubs

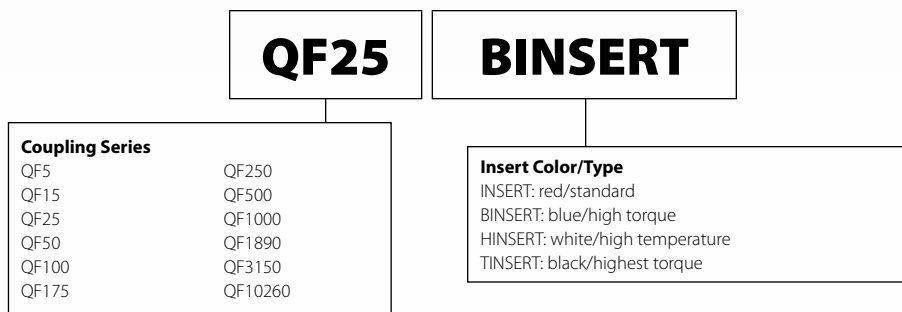

Fig.2. Inserts

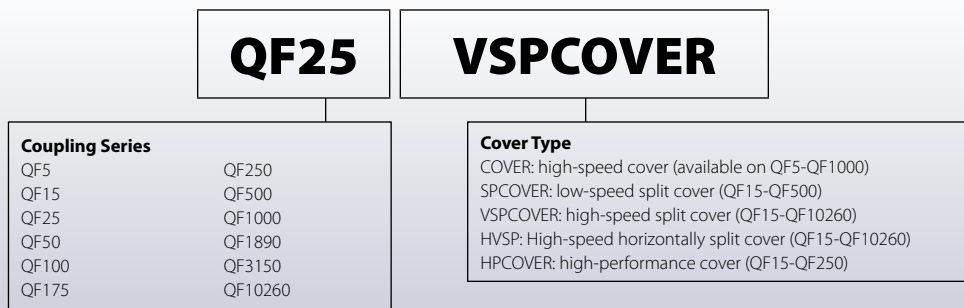

Fig. 3. Covers

Spacer Coupling Nomenclature

A complete *single-ended* spacer coupling unit consists of:

- One standard hub
- One flanged spacer hub
- One single-ended spacer body
- One insert
- One cover

A complete *double-ended* spacer coupling unit consists of:

- Two standard hubs
- One double-ended spacer body
- Two inserts
- Two covers

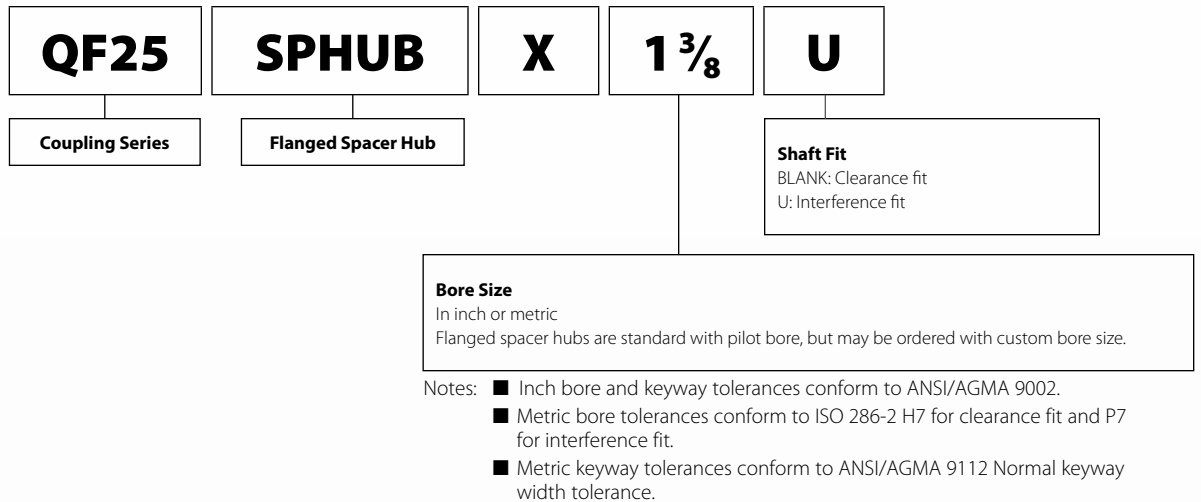

Fig. 4. Flanged spacer hubs

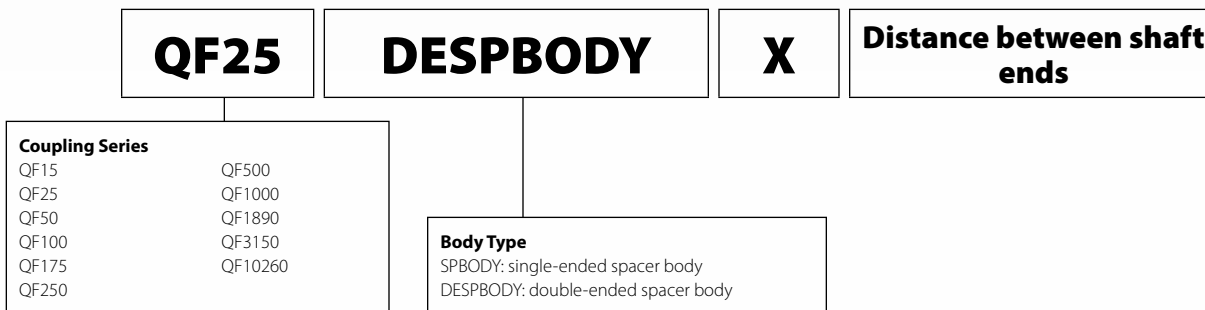

Fig. 5. Flanged spacer bodies

Coupling Interchange Chart

Gear Couplings



Tecnon Gear Couplings

QUICK FLEX® with black insert high-speed split cover

Part #	Torque Nm	Max Bore mm	Part #	Torque Nm	Max Bore mm
101	1,140	44	QF25	1,407	50
101-1/4	1,756	47	QF50	2,992	60
101-1/2	2,348	60	QF50	2,992	60
102	4,269	73	QF100	6,061	75
102-1/2	7,470	92	QF175	9,973	95
103	12,094	105	QF250	13,438	105
103-1/2	18,469	123	QF1000	35,081	140
104	30,590	146	QF1000	35,081	140
104-1/2	41,971	171	QF1890	62,597	175
105	56,580	183	QF1890	62,597	175
105-1/2	73,985	205	QF3150	98,434	205
106	90,345	230	QF3150	98,434	205
107	135,160	270	QF10260	188,794	280

ERHSA Gear Couplings

QUICK FLEX® with black insert high-speed split cover

Part #	Torque Nm	PM	FB	Part #	Torque Nm	Max Bore mm
		Max Bore mm	Max Bore mm			
PM/FB-1	638	41	37	QF25	1,407	50
PM/FB-1-1/4	1,177	46	40	QF25	1,407	50
PM/FB-1-1/2	1,864	56	50	QF50	2,992	60
PM/FB-2	3,728	71	70	QF100	6,061	75
PM/FB-2-1/2	6,376	83	80	QF175	9,973	95
PM/FB-3	10,555	96	90	QF250	13,438	105
PM/FB-3-1/2	15,814	112	100	QF1000	35,081	140
PM/FB-4	24,329	130	115	QF1000	35,081	140
PM/FB-4-1/2	33,844	148	130	QF1890	62,597	175
PM/FB-5	43,164	160	140	QF1890	62,597	175
PM/FB-5-1/2	54,936	175	160	QF3150	98,434	205
PM/FB-6	70,632	200	175	QF3150	98,434	205

Coupling Interchange Chart

Gear Couplings



Falk® Gear Type GL52 - Single Engagement

QUICK FLEX® with black insert high-speed split cover

Part #	Torque Nm	Max Bore mm	Part #	Torque Nm	Max Bore mm
1035G	16,373	124	QF1000	35,081	140
1040G	24,915	146	QF1000	35,081	140
1045G	34,169	171	QF1890	62,597	175

Falk® Gear Type GL20 - Double Engagement

QUICK FLEX® with black insert high-speed split cover

Part #	Torque Nm	Max Bore mm	Part #	Torque Nm	Max Bore mm
1010G	854	47	QF25	1,407	50
1015G	1,922	60	QF50	2,992	60
1020G	3,559	73	QF100	6,061	75
1025G	6,407	92	QF175	9,973	95
1030G	10,678	104	QF250	13,438	105
1035G	16,373	123	QF1000	35,081	140
1040G	24,915	146	QF1000	35,081	140
1045G	34,169	171	QF1890	62,597	175
1050G	46,271	187	QF1890	62,597	175
1055G	60,508	210	QF3150	98,434	205
1060G	78,305	232	QF3150	98,434	205
1070G	113,898	276	QF10260	188,794	280

KTR GEARex® Gear Couplings

QUICK FLEX® with black insert high-speed split cover

Part #	Torque Nm	Max Bore mm	Part #	Torque Nm	Max Bore mm
10	930	50	QF25	1,407	50
15	2,000	64	QF50	2,992	60
20	3,500	80	QF100	6,061	75
25	6,500	98	QF175	9,973	95
30	10,000	112	QF250	13,438	105
35	17,000	133	QF1000	35,081	140
40	28,500	158	QF1000	35,081	140
45	37,000	172	QF1890	62,597	175
50	51,000	192	QF1890	62,597	175
55	65,000	210	QF3150	98,434	205
60	85,000	232	QF3150	98,434	205
70	135,000	276	QF10260	188,794	280

Coupling Interchange Chart

Gear Couplings



MAINA GO-A Gear Couplings

QUICK FLEX® with black insert high-speed split cover

Size	Torque Nm	Max Bore mm	Part #	Torque Nm	Max Bore mm
0	1,800	52	QF50	2,992	60
1	2,760	62	QF50	2,992	60
2	5,550	78	QF100	6,061	75
3	8,700	98	QF175	9,973	95
4	14,100	112	QF250	13,438	105
5	22,800	132	QF1000	35,081	140
6	34,800	156	QF1000	35,081	140
7	44,000	174	QF1890	62,597	175
8	69,800	190	QF3150	98,434	205
9	83,800	210	QF3150	98,434	205
10	152,000	233	QF10260	188,794	280
11	203,500	280	QF10260	188,794	280

Escogear FST Gear Couplings

QUICK FLEX® with black insert high-speed split cover

Size	Torque Nm	Max Bore mm	Part #	Torque Nm	Max Bore mm
45	1,300	50	QF25	1,407	50
60	2,800	64	QF50	2,992	60
75	5,000	75	QF100	6,061	75
95	10,000	95	QF175	9,973	95
110	16,000	110	QF250	13,438	105
130	22,000	130	QF1000	35,081	140
155	32,000	155	QF1000	35,081	140
175	45,000	175	QF1890	62,597	175
195	62,000	195	QF1890	62,597	175
215	84,000	215	QF3150	98,434	205
240	115,000	240	QF10260	188,794	280
275	174,000	275	QF10260	188,794	280

Coupling Interchange Chart

Gear Couplings



Flender ZAPEX® ZWN Gear Couplings

QUICK FLEX® with black insert high-speed split cover

Size	Torque Nm	Max Bore mm	Part #	Torque Nm	Max Bore mm
112	1,300	45	QF25	1,407	50
128	2,500	55	QF50	2,992	60
146	4,300	65	QF100	6,061	75
175	7,000	80	QF175	9,973	95
198	11,600	95	QF250	13,438	105
230	19,000	110	QF500	24,794	115
255	27,000	125	QF1000	35,081	140
290	39,000	145	QF1890	62,597	175
315	54,000	160	QF1890	62,597	175
342	69,000	180	QF3150	98,434	205
375	98,000	200	QF3150	98,434	205
415	130,000	220	QF10260	188,794	280
465	180,000	250	QF10260	188,794	280
505	250,000	275	Contact Lovejoy Customer Service at 630-852-0500, or customerservice@lovejoy-inc.com		
545	320,000	300			
585	400,000	330			

Flender ZAPEX® ZIN Gear Couplings

QUICK FLEX® with black insert high-speed split cover

Part #	Torque Nm	Max Bore mm	Part #	Torque Nm	Max Bore mm
1	850	50	QF25	1,407	50
1.5	1,700	64	QF50	2,992	60
2	3,350	80	QF100	6,061	75
2.5	6,000	98	QF175	9,973	95
3	10,000	112	QF250	13,438	105
3.5	16,000	133	QF1000	35,081	140
4	23,600	158	QF1000	35,081	140
4.5	33,500	172	QF1890	62,597	175
5	47,500	192	QF1890	62,597	175
5.5	67,000	210	QF3150	98,434	205
6	90,000	232	QF3150	98,434	205
7	125,000	276	QF10260	188,794	280

Coupling Interchange Chart

Gear Couplings



JAURE® Type MT Gear Couplings

QUICK FLEX® with black insert high-speed split cover

Size	Torque Nm	Max Bore mm	Part #	Torque Nm	Max Bore mm
52	1,780	52	QF50	2,992	60
62	2,790	62	QF50	2,992	60
78	5,600	78	QF100	6,061	75
98	8,500	98	QF175	9,973	95
112	14,000	112	QF250	13,438	105
132	23,000	132	QF1000	35,081	140
156	35,100	156	QF1000	35,081	140
174	44,400	174	QF1890	62,597	175
190	68,500	190	QF3150	98,434	205
210	84,600	210	QF3150	98,434	205
233	151,000	233	QF10260	188,794	280
275	205,500	275	QF10260	188,794	280

Ameridrives® Amerigear® Series F Gear Couplings

QUICK FLEX® with blue insert high-speed split cover

Part #	Torque in. - lbs.	Max Bore in.	Part #	Torque in. - lbs.	Max Bore in.
201	3,200	1.25	QF15	4,001 ⁽⁵⁾	1.625
201-1/4	7,600	1.63	QF25	8,077	2.125
201-1/2	17,000	2.25	QF50	17,502	2.375
202	31,500	2.75	QF100	35,144	3
202-1/2	53,600	3.5	QF175	58,903	3.875
203	94,500	4	QF250	118,930 ⁽⁵⁾	4.125
203-1/2	142,000	4.5	QF500	144,372	4.5
204	214,000	5.5	QF1000	310,466 ⁽⁵⁾	5.125
204-1/2	324,000	6.25	QF1890	344,594	6.5
205	416,000	6.62	QF1890	553,982 ⁽⁵⁾	6.5
205-1/2	551,000	7.5	QF3150	566,434	8
206	750,000	8.25	QF10260	1,131,179	11
207	1,033,000	9.62	QF10260	1,131,179	11

(5) Black insert with high-speed split cover



Coupling Interchange Chart

Gear Couplings



KTR BoWex® Nylon Gear Couplings

QUICK FLEX® with red insert and high-speed cover

Part #	Torque Nm	Max Bore mm	Part #	Torque Nm	Max Bore mm
M-14	10	15	QF 5	43	25
M-19	16	20	QF 5	43	25
M-24	20	24	QF 5	43	25
M-28	45	28	QF 5	43	25
M-32	60	32	QF15	120	40
M-38	80	38	QF15	120	40
M-42	100	42	QF15	120	40
M-48	140	48	QF25	387	50
M-65	380	65	QF50	798	60
I-80	700	80	QF175	2,780	95
I-100	1,200	100	QF175	2,780	95
I-125	2,500	125	QF500	6,790	115

Coupling Interchange Chart

Grid Couplings

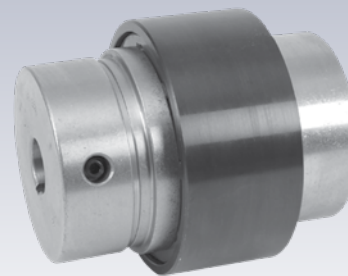

Falk® Steelflex® Type T10 Grid Couplings

QUICK FLEX® with black insert high-speed split cover

Part #	Torque Nm	Max Bore mm	Part #	Torque Nm	Max Bore mm
1020T	48	29	QF15	452	40
1030T	136	35	QF15	452	40
1040T	226	41	QF15	452	40
1050T	395	48	QF25	1,407	50
1060T	621	54	QF25	1,407	50
1070T	904	64	QF50	2,922	60
1080T	1,864	76	QF100	6,061	75
1090T	3,390	89	QF175	9,973	95
1100T	5,706	102	QF250	13,438	105
1110T	8,475	114	QF500	24,794	115
1120T	12,429	127	QF1000	35,081	140
1130T	18,079	152	QF1000	35,081	140
1140T	25,989	184	QF1890	62,597	175
1150T	36,158	203	QF3150	98,434	205

Coupling Interchange Chart

Elastomeric Couplings



Rexnord® Omega® Tire Couplings

QUICK FLEX® with red insert and high-speed cover

Part #	Torque Nm	Max Bore mm	Part #	Torque Nm	Max Bore mm
E2	22	28	QF 5	93 ⁽²⁾	25
E3	41	34	QF15	120	40
E4	62	42	QF15	120	40
E5	105	48	QF25	387	50
E10	164	55	QF25	387	50
E20	260	60	QF25	387	50
E30	412	75	QF100	1,602	75
E40	622	85	QF175	2,780	95
E50	864	90	QF175	2,780	95
E60	1,412	105	QF250	3,513	105
E70	2,490	120	QF500	6,790	115
E80	4,460	155	QF1000	9,601	140
E100	9,600	171	QF1890	19,869 ⁽³⁾	175
E120	19,200	190	QF1890	19,869 ⁽³⁾	175
E140	38,400	229	QF3150	64,004 ⁽²⁾⁽³⁾	205

(2) Blue insert with high-speed split cover

(3) Torque ratings using our high-speed split cover

Rex® Viva™ Tire Couplings

QUICK FLEX® with red insert and high-speed cover

Part #	Torque Nm	Max Bore mm	Part #	Torque Nm	Max Bore mm
VS110	62	38	QF15	120	40
VS125	105	42	QF15	120	40
VS130	164	55	QF25	387	50
VS150	250	65	QF50	798	60
VS170	308	65	QF50	798	60
VS190	412	75	QF100	1,602	75
VS215	662	80	QF175	2,780	95
VS245	938	95	QF175	2,780	95
VS290	1,412	110	QF500	6,790	115
VS365	3,200	127	QF500	6,790	115
VS425	5,580	155	QF1000	9,601	140
VS460	6,270	165	QF1890	19,869 ⁽³⁾	175

(3) Torque ratings using our high-speed split cover

Coupling Interchange Chart

Elastomeric Couplings



Dodge® PARA-FLEX® Tire Couplings

QUICK FLEX® with red insert high-speed split cover

Size	Max Bore in.	Torque in-lbs	Part #	Max Bore in.	Torque in-lbs.
PX40	1.437	429	QF15	1.625 ⁽¹⁾	1,059
PX50	1.875	900	QF25	2.125 ⁽¹⁾	3,426
PX60	1.5	1,800	QF25	2.125	3,426 ⁽³⁾
PX70	2.375	2,200	QF50	2.375 ⁽²⁾	7,066
PX80	2.875	3,605	QF100	3	14,178
PX90	3.25	4,502	QF175	3.875 ⁽²⁾	24,602
PX100	3.25	5,402	QF175	3.875 ⁽²⁾	24,602
PX110	3.937	7,750	QF250	4.125 ⁽²⁾	31,091
PX120	4	12,605	QF250	4.125 ⁽²⁾	31,091
PX140	4.5	27,590	QF500	4.5 ⁽²⁾	60,09 ⁽³⁾
PX160	6	37,800	QF1000	7	84,966 ⁽³⁾
PX200	6.75	82,500	QF1890	7 ⁽⁴⁾	95,061
PX240	7.5	151,200	QF3150	8 ⁽²⁾	105,135 ⁽³⁾⁽⁴⁾

(1) Check required bore

(2) Check required bore, smaller size may be suitable

(3) Smaller size coupling may be suitable using split cover and/or higher torque insert

(4) Split cover only

Coupling Interchange Chart

Elastomeric Couplings



Falk® Wrapflex® Wrap-Style Couplings

QUICK FLEX® with red insert and high-speed cover

Part #	Torque Nm	Max Bore mm	Part#	Torque Nm	Max Bore mm
5R	62	38	QF15	120	40
10R	130	48	QF25	387	50
20R	320	60	QF25	387	50
30R	520	65	QF50	798	60
40R	1,030	85	QF175	2,780	95
50R	2,500	105	QF250	3,513	105
60R	4,000	135	QF1000	9,601	140
70R	8,000	160	QF1890	19,869 ⁽³⁾	175
80R	15,000	190	QF3150	33,942 ⁽³⁾	205

(3) Torque ratings using our high-speed split cover

Samiflex Type A Wrap-Style Couplings

QUICK FLEX® with red insert high-speed cover

Part #	Torque Nm	Max Bore mm	Part #	Torque Nm	Max Bore mm
A-0	55	24	QF 5	93 ⁽²⁾	25
A-1	138	38	QF15	120	40
A-2	275	44	QF25	387	50
A-3	550	50	QF25	730 ⁽²⁾	50
A-3B	569	58	QF50	798	60
A-4	1,550	65	QF50	1,978 ⁽²⁾	60
A-4B	1,550	70	QF175	2,780	95
A-45	2,700	75	QF100	3,971 ⁽²⁾	75
A-5B	2,876	95	QF500	6,790	115
A-55	3,737	95	QF250	3,513	105
A-6	4,599	110	QF500	6,790	115
A-7	9,169	130	QF1000	9,601	140
A-8	17,227	150	QF1890	19,869 ⁽³⁾	175
A-9	28,688	180	QF1890	38,937 ⁽²⁾	175
A-10	45,986	210	QF3150	64,004 ⁽²⁾	205
A-11	55,953	210	QF3150	64,004 ⁽²⁾	205

(2) Blue insert with high-speed split cover

(3) Torque ratings using our high-speed split cover

Coupling Interchange Chart

Elastomeric Couplings



ATRA-FLEX® A Series Wrap-Style Couplings

ATRA-FLEX® A Series Wrap-Style Couplings			QUICK FLEX® with red insert and high-speed cover		
Size	Torque in. - lbs.	Max Bore in.	Part #	Torque in. - lbs.	Max Bore in.
A-0	265	1.25	QF 5	377	1.250
A-1	340	1.625	QF15	1,059	1.625
A-2	1,325	1.9375	QF25	3,426	2.125
A-3	2,650	2.375	QF50	7,066	2.375
A-4	5,300	2.9375	QF100	14,178	3.00
A-5	13,230	4.000	QF250	31,091	4.125
A-6	21,200	5.000	QF500	60,091	4.500
A-7	42,350	6.000	QF1000	106,208 ⁽³⁾	6.188
A-8	79,400	7.125	QF1890	175,840 ⁽³⁾	7.563
A-9	120,300	9.250	QF3150	300,387 ⁽³⁾	9.125
A-11	300,000	10.500	QF10260	600,494 ⁽³⁾	11.250

(3) Torque ratings using our high-speed split cover

ATRA-FLEX® Millennium® Wrap-Style Couplings

ATRA-FLEX® Millennium® Wrap-Style Couplings			QUICK FLEX® with blue insert and high-speed cover		
Part #	Torque in. - lbs.	Max Bore in.	Part #	Torque in. - lbs.	Max Bore in.
M-0	600	1.375	QF 5	819	1.250
M-1	1,260	1.625	QF15	2,075	1.625
M-2	3,000	2.250	QF25	6,461	2.125
M-3	5,760	2.500	QF50	14,002	2.375
M-4	12,600	3.250	QF100	28,115	3.00
M-5	28,800	4.500	QF250	61,726	4.125
M-6	48,000	5.500	QF500	115,497	4.500
M-7	111,000	6.000	QF1000	203,746 ⁽³⁾	6.188
M-8	186,600	7.250	QF1890	344,594 ⁽³⁾	7.563
M-9	273,000	9.000	QF3150	566,434 ⁽³⁾	9.125
M-10	420,000	10.000	QF10260	1,131,179 ⁽³⁾	11.250
M-12	960,000	13.250	QF10260	1,131,179 ⁽³⁾	11.250

(3) Torque ratings using our high-speed split cover



Coupling Interchange Chart

Elastomeric Couplings



KTR ROTEX® Curved Jaw Couplings

QUICK FLEX® with red insert and high-speed cover

Part #	Torque Nm	Max Bore mm	Part #	Torque Nm	Max Bore mm
14	16	16	QF 5	43	25
19	21	25	QF 5	43	25
24	75	35	QF15	120	40
28	200	40	QF15	293 ⁽²⁾	40
38	405	48	QF25	387	50
42	560	55	QF25	913 ⁽²⁾	50
48	655	62	QF50	798	60
55	825	74	QF100	1,602	75
65	1,175	80	QF175	2,780	95
75	2,400	95	QF175	2,780	95
90	4,500	110	QF250	4,391 ⁽³⁾	105

(2) Blue insert with high-speed split cover

(3) With high-speed split cover

KTR POLY-NORM® AR Jaw Couplings

QUICK FLEX® with red insert and high-speed cover

Part #	Torque Nm	Max Bore mm	Part #	Torque Nm	Max Bore mm
28	40	30	QF 5	43	25
32	60	35	QF15	120	40
38	90	40	QF15	120	40
42	150	45	QF25	387	50
48	220	50	QF25	387	50
55	300	60	QF50	798	60
60	410	65	QF100	1,602	75
65	550	70	QF100	1,602	75
75	850	80	QF175	2,780	95
85	1,350	90	QF175	2,780	95
90	2,000	95	QF175	2,780	95
100	2,900	110	QF500	6,790	115
110	3,900	120	QF1000	9,601	140
125	5,500	140	QF1000	9,601	140
140	7,200	155	QF1000	9,601	140
160	10,000	175	QF1890	10,740	175
180	13,400	200	QF3150	33,942 ⁽³⁾	205

(3) With high-speed split cover

Coupling Interchange Chart

Elastomeric Couplings



Flender N-EUPEX Type A Pin Couplings

			QUICK FLEX® with red insert and high-speed cover		
Size	Torque Nm	Max Bore mm	Part #	Torque Nm	Max Bore mm
110	160	48	QF25	387	50
125	240	55	QF25	387	50
140	360	60	QF25	387	50
160	560	65	QF50	798	60
180	880	75	QF100	1,602	75
200	1,340	85	QF175	2,780	95
225	2,000	90	QF175	2,780	95
250	2,800	100	QF175	2,780	95
280	3,900	110	QF500	6,790	115
315	5,500	120	QF1000	9,601	140
350	7,700	140	QF1000	9,601	140
400	10,300	150	QF1000	12,001 ⁽¹⁾	140
440	13,500	160	QF1890	19,869 ⁽¹⁾	175
480	16,600	180	QF1890	19,869 ⁽¹⁾	175
520	21,200	190	QF3150	33,942 ⁽¹⁾	205
560	29,000	200	QF3150	33,942 ⁽¹⁾	205
610	38,000	220	QF3150	64,004 ⁽²⁾	205
660	49,000	240	QF10260	67,852 ⁽¹⁾	280
710	62,000	260	QF10260	67,852 ⁽¹⁾	280

(1) With high-speed split cover

(2) Blue insert with high-speed split cover

Flender N-EUPEX Type B Pin Couplings

			QUICK FLEX® with red insert and high-speed cover		
Size	Torque Nm	Max Bore mm	Part #	Torque Nm	Max Bore mm
58	19	19	QF5	43	25
68	34	24	QF15	120	40
80	60	30	QF25	387	50
95	100	42	QF25	387	50
110	160	48	QF25	387	50
125	240	55	QF25	387	50
140	360	60	QF25	387	50
160	560	65	QF50	798	60
180	880	75	QF100	1,602	75
200	1,340	85	QF175	2,780	95
225	2,000	90	QF175	2,780	95
250	2,800	100	QF175	2,780	95
280	3,900	110	QF500	6,790	115

Coupling Interchange Chart

Elastomeric Couplings



TSCHAN® S-ST and S-LST Curved Jaw Couplings

				QUICK FLEX® with red insert and high-speed cover		
Style	Part #	Torque Nm	Max Bore mm	Part #	Torque Nm	Max Bore mm
S-ST S-LST	50	15	25	QF 5	43	25
S-ST	70	55	38	QF15	120	40
S-ST S-LST	85	110	40	QF15	120	40
S-ST S-LST	100	195	42	QF15	293 ⁽²⁾	42
S-ST S-LST	125	370	55	QF25	387	50
S-ST S-LST	145	600	65	QF50	798	60
S-ST S-LST	170	950	85	QF175	2,780	95
S-ST S-LST	200	1,650	95	QF175	2,780	95
S-ST S-LST	230	2,580	105	QF250	3,513	105
S-ST S-LST	260	3,980	125	QF500	6,790	115
S-ST	300	5,850	140	QF1000	9,601	140
S-ST	360	9,700	150	QF1890	10,740	175
S-ST S-LST	400	13,350	160	QF1890	19,869 ⁽³⁾	175

(2) Blue insert with high-speed split cover

(3) With high-speed split cover

Flender BIPEX® Type BWN Curved Jaw Couplings

			QUICK FLEX® with red insert and high-speed cover		
Part #	Torque Nm	Max Bore mm	Part #	Torque Nm	Max Bore mm
43	14	25	QF5	43	25
53	24	30	QF15	120	40
62	42	35	QF15	120	40
72	75	42	QF15	120	40
84	130	48	QF25	387	50
97	220	50	QF25	387	50
112	360	60	QF25	387	50
127	550	65	QF50	798	60
142	800	75	QF100	1,602	75
162	1,250	80	QF175	2,780	95
182	1,750	90	QF175	2,780	95
202	2,650	100	QF250	3,513	105
227	3,700	110	QF500	6,790	115



Coupling Interchange Chart

Elastomeric Couplings

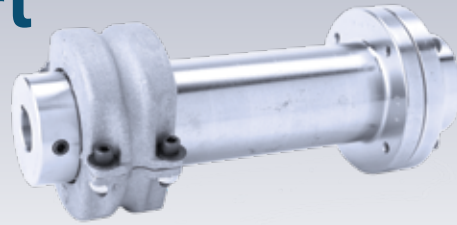

Flender RUPEX® Type RWN Pin & Bush Couplings

			QUICK FLEX® with red insert high-speed cover		
Part #	Torque Nm	Max Bore mm	Part #	Torque Nm	Max Bore mm
105	200	32	QF15	120	40
125	350	40	QF25	387	50
144	500	45	QF50	998	60
162	750	50	QF50	998	60
178	950	60	QF50	998	60
198	1,300	70	QF100	1,602	75
228	2,200	80	QF175	2,780	95
252	2,750	90	QF175	2,780	95
285	4,300	100	QF250	3,513	105
320	5,500	110	QF500	6,790	115
360	7,800	120	QF1000	9,601	140
400	12,500	140	QF1000	12,001 ⁽²⁾	140
450	18,500	160	QF1000	23,022 ⁽³⁾	140
500	25,000	180	QF1890	19,869 ⁽²⁾	175
560	39,000	200	QF3150	64,004 ⁽³⁾	205
630	52,000	220	QF10260	67,852 ⁽²⁾	280
710	84,000	240	QF10260	127,817 ⁽³⁾	280

(2) With high-speed split cover

(3) Blue insert with high-speed split cover

KTR REVOLEX® KX Pin & Bush Couplings

			QUICK FLEX® with red insert high-speed split cover		
Part #	Torque Nm	Max Bore mm	Part #	Torque Nm	Max Bore mm
KX-D-75	3,800	90	QF175	6,656 ⁽²⁾	95
KX-D-85	5,000	100	QF250	8,718 ⁽²⁾	105
KX-D-95	6,600	110	QF500	8,497	115
KX-D-105	8,650	120	QF1000	12,001	140
KX-D-120	14,110	140	QF1000	23,022 ⁽²⁾	140
KX-D-135	18,690	160	QF1890	19,869	175
KX-D-150	23,100	185	QF1890	38,937 ⁽²⁾	175
KX-D-170	36,900	220	QF10260	67,852	280
KX-D-190	48,210	245	QF10260	67,852	280
KX-D-215	61,900	275	QF10260	67,852	280
KX-D-240	92,030	310	Contact Lovejoy Customer Service at 630-852-0500, or customerservice@lovejoy-inc.com		
KX-D-265	121,900	350			
KX-D-280	158,800	385			
KX-D-305	191,060	405			

(2) Blue insert with high-speed split cover



Coupling Interchange Chart

Elastomeric Couplings



SureFlex®, QuadraFlex® Shear Type Couplings

			QUICK FLEX® with red insert and high-speed cover		
Size	Max Bore in.	Torque in-lbs	Part #	Max Bore in.	Torque in-lbs.
3J	0.875	60	QF5	1.25	377
4J	1	120	QF5	1.25	377
5J	1.125	240	QF5	1.25	377
6S	1.437	450	QF5	1.25	377
7S	1.625	725	QF15	1.625 ⁽¹⁾	1,059
8S	1.937	1,135	QF25	2.125	3,426
9S	2.375	1,800	QF50	2.375 ⁽²⁾	7,066
10S	2.75	2,875	QF100	3	14,178
11S	3.375	4,530	QF175	3.875	24,602
12S	3.875	7,200	QF175	3.875	24,602

(1) Check required bore

(2) Check required bore, smaller size may be suitable

Magnaloy Jaw Couplings

			QUICK FLEX® with red insert and high-speed cover		
Size	Max Bore in.	Torque in-lbs	Part #	Max Bore in.	Torque in-lbs
100	1.125	341	QF5	1.25	377
200	1.375	398	QF15	1.625 ⁽²⁾	1,059
300	1.625	701	QF15	1.625	1,059
400	1.875	1056	QF25	2.125 ⁽²⁾	3,426
500	2.375	2,195	QF50	2.375 ⁽²⁾	7,066
600	2.625	4,947	QF100	3 ⁽²⁾	14,178
700	2.875	11,640	QF100	3	14,178
800	3.875	21,889	QF175	3.875 ⁽⁴⁾	24,602
900	4.75	47,842	QF1000	5.5 ^{(2) (4)}	84,966

(2) Check required bore, smaller size may be suitable

(4) Split cover only

Coupling Interchange Chart

Elastomeric Couplings



KOP-FLEX® Elastomeric® Wrap Style Couplings

QUICK FLEX® with red insert and high-speed cover

Size	Max Bore in.	Torque in-lbs	Part #	Max Bore in.	Torque in-lbs.
20E	1.188	217	QF5	1.25	377
30E	1.625	418	QF15	1.625	1,059
40E	2	725	QF25	2.125	3,426
50E	2.25	1,260	QF50	2.375 ⁽²⁾	7,066
60E	3	1,920	QF100	3	14,178
70E	3.25	4,540	QF175	3.875 ⁽²⁾	24,602
80E	4.125	8,190	QF250	4.125 ⁽²⁾	31,091
90E	5.125	14,200	QF1000	5.5 ⁽²⁾	84,966
100E	5.625	26,500	QF1000	7 ⁽²⁾	84,966

(2) Check required bore, smaller size may be suitable

Coupling Interchange Chart

Disc Couplings



KTR RADEX-N® Disc Couplings

QUICK FLEX® with red insert and high-speed cover

Size	Torque Nm	Max Bore mm	Part #	Torque Nm	Max Bore mm
20	15	20	QF 5	43	25
25	30	25	QF 5	43	25
35	60	35	QF15	120	40
38	120	38	QF15	120	40
42	180	42	QF15	293 ⁽¹⁾	40
50	330	50	QF25	387	50
60	690	60	QF25	913 ⁽¹⁾	50
70	1,100	70	QF100	1,602	75
80	1,500	80	QF175	2,780	95
85	2,400	85	QF175	2,780	95
90	4,500	90	QF175	6,656 ⁽¹⁾	95
105	5,100	105	QF250	8,718 ⁽¹⁾	105
115	9,000	115	QF500	16,313 ⁽¹⁾	115
135	12,000	135	QF1000	12,001 ⁽²⁾	140
136	17,500	135	QF1000	23,022 ⁽¹⁾	140
156	25,000	150	QF1000	23,022 ⁽¹⁾	140
166	35,000	165	QF1890	38,937 ⁽¹⁾	175
186	42,000	180	QF1890	62,597 ⁽³⁾	175
206	52,500	200	QF3150	64,004 ⁽¹⁾	205
246	90,000	240	QF10260	188,794 ⁽³⁾	280
286	150,000	280	QF10260	188,794 ⁽³⁾	280

(1) Blue insert with high-speed split cover

(2) With high-speed split cover

(3) Black insert with high-speed cover

Note: Check the QUICK FLEX catalog (order no. 10509) for more data.
Lovejoy engineers confirm torque ratings by performing FEA analysis on QUICK FLEX components.

Coupling Interchange Chart

Chain Couplings



Chain Couplings			QUICK FLEX® with red insert and high-speed cover		
Size	Max Bore in.	Torque in-lbs	Part #	Max Bore in.	Torque in-lbs.
4012	0.875	1,355	QF5	1.25	377 ⁽⁵⁾
4016	1.362	2,414	QF15	1.625	1,059 ⁽⁵⁾
5012	1.125	2,540	QF15	1.625	1,059 ⁽⁵⁾
5016	1.688	4,613	QF25	2.125	3,426 ⁽⁵⁾
5018	2	5,968	QF25	2.125	3,426 ⁽⁵⁾
6018	2.437	10,903	QF50	2.375	7,066 ⁽¹⁾⁽⁵⁾
6020	2.75	14,180	QF100	3	14,178 ⁽⁵⁾
8018	3.125	24,238	QF175	3.875	24,602 ⁽²⁾⁽⁵⁾
8020	3.562	31,701	QF175	3.875	24,602 ⁽⁵⁾
10020	4.625	54,705	QF500	4.5	60,091 ⁽¹⁾⁽⁴⁾
12018	4.688	86,344	QF1000	5.5	84,966 ⁽⁶⁾

(1) Check required bore

(2) Check required bore, smaller size may be suitable

(4) Split cover only

(5) High torque insert

(6) Verify required torque for insert type

Notes

QUICK FLEX® Couplings

Easy-to-install elastomeric couplings designed to withstand harsh conditions.



Better Performance. Less Maintenance.



Lovejoy, LLC
2655 Wisconsin Avenue
Downers Grove, IL 60515

630-852-0500
630-852-2120 fax
info@lovejoy-inc.com

www.lovejoy-inc.com

ISO 9001 Certified